



## CG / CGV / AG / AGV

# Supporti per la regolazione dei cilindri allargatori Supports for the spreader rollers' adjustment

### MED 60 - 100 / MED 100 - 130

tipo type	A	B	C	D	E	F	G	H	I	L	M	N
MED 60-100	135	160	60	110	80	88	200	160	35	M12	13	12.7
MED 100-130	175	200	70	120	102.5	111.5	255	205	45	M14	15	19

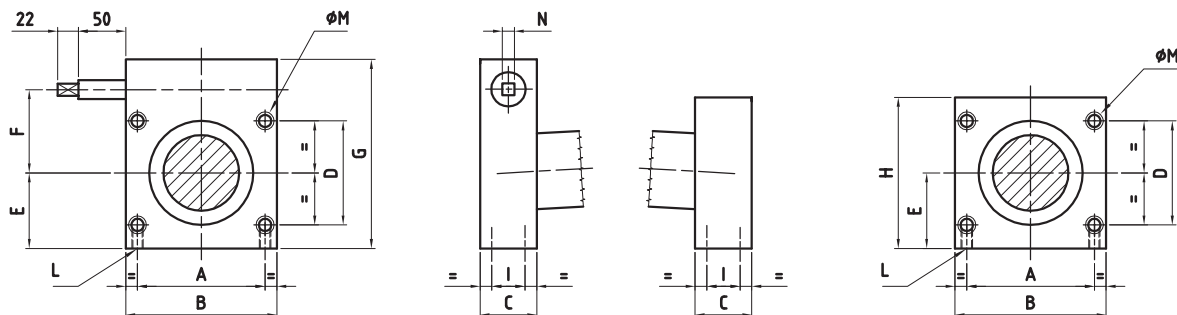

### MAX 60 - 80 FLANGIA / FLANGE

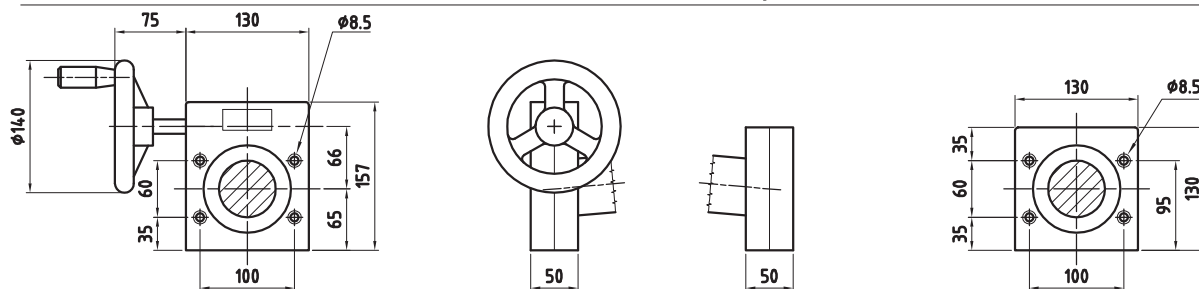

### MAX 45 - 50 FLANGIA / FLANGE

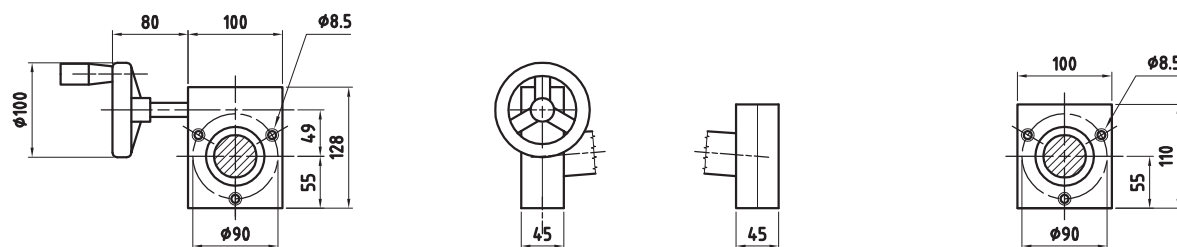

### MED 30 - 35 FLANGIA / FLANGE

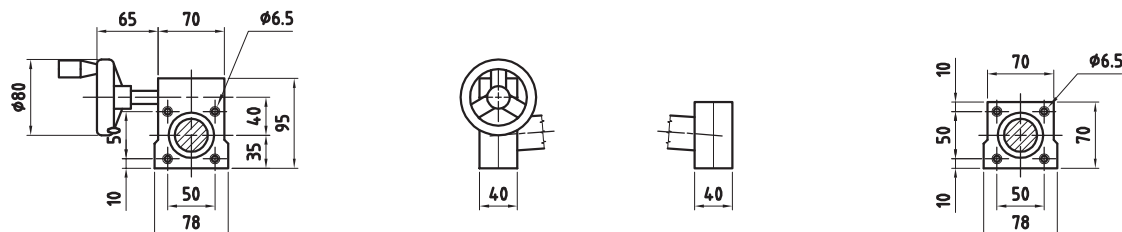

### MIN 25 - 30 FLANGIA / FLANGE

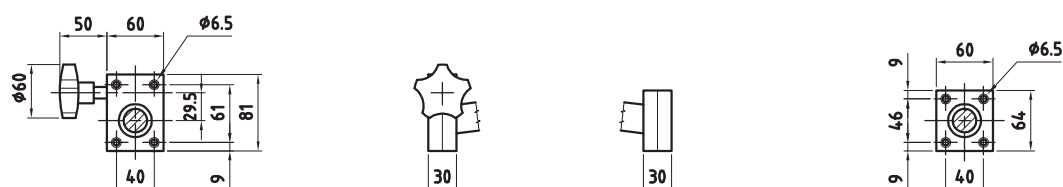



## CG / CGV / AG / AGV

# Supporti per la regolazione dei cilindri allargatori Supports for the spreader rollers' adjustment

FISSI / FIX

tipo type	A	B	C	D
Ø 30	95	42	10.5	76
Ø 60	150	60	14.5	115

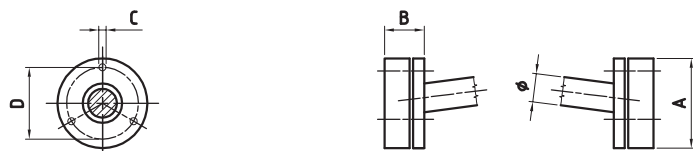

### MAX 60 - 80 BASE

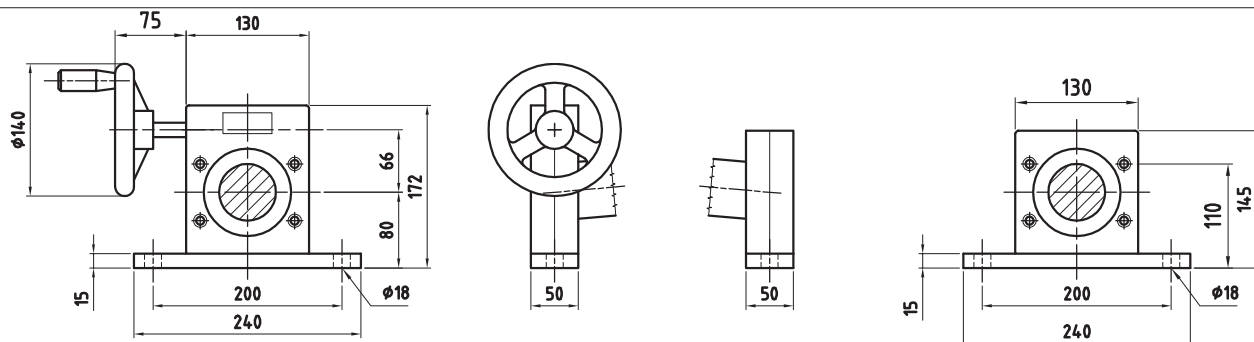

### MAX 45 - 50 BASE

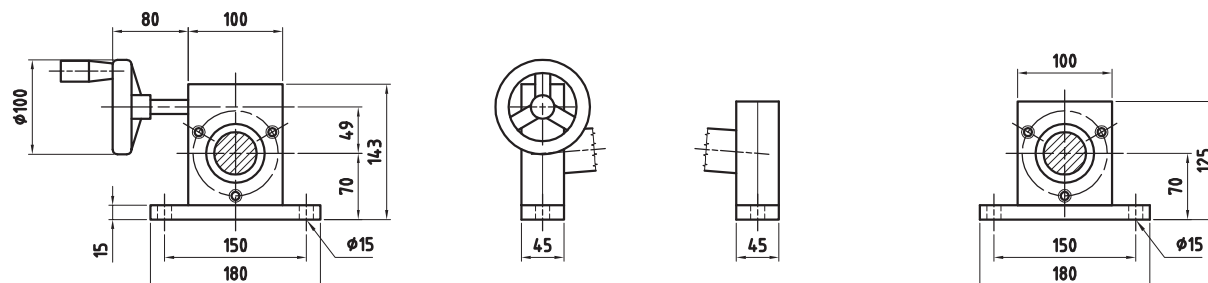

### MED 30 - 35 BASE

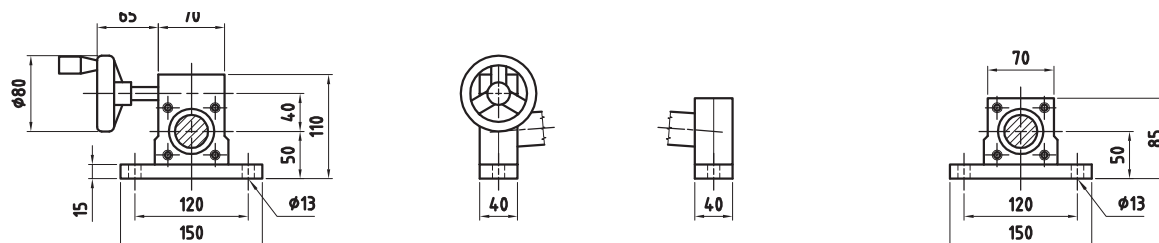

### MIN 25 - 30 BASE

